



# GASON<sup>®</sup>



**Producer Proven  
and Built to Last...  
Because it's Gason**

**PRODUCT CATALOGUE**

# Welcome to Gason

In 1946 Arthur 'Frank' Gason founded a small, family owned and operated motor trimming business in Ararat, Western Victoria.

Many innovative products were developed and in 1958 the company was asked to build a cabin for a Minneapolis Moline GTA (Twin City) tractor. Frank and his staff did so with their renowned thoroughness creating a standard for Gason agricultural equipment that continues to this day.

It was the first of many. Tens of thousands of tractor cabins were produced over the following 40 years, carrying the Gason name onto farms in every corner of Australia.

By the mid-1970's Gason tractor cabins became 'the standard' and were fitted as original equipment in tractor company plants across Australia. Major international

tractor manufacturers such as International, Caterpillar and John Deere joined their Australian counterparts in making Gason Cabs their standard.

When, inevitably, international tractor manufacturers started to import tractors into Australia with cabins pre-fitted, the company moved towards developing its roots in agriculture, designing and manufacturing cultivation equipment and air seeders that were suited to our unique Australian conditions.

Today, Gason are continuing their research into new and innovative products. We work in collaboration with engineers, farmers and farm innovation groups throughout Australia to find products which can assist farmers - increasing productivity and maximising profitability.



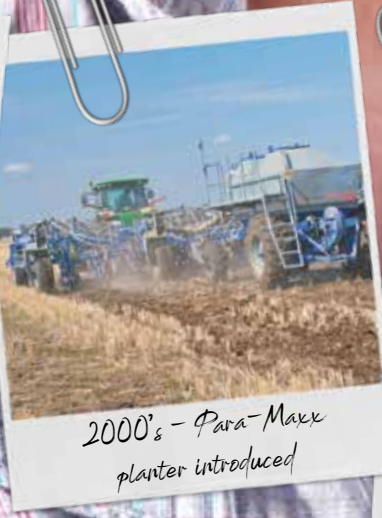

2000's - Para-Maxx  
planter introduced



2010 - CGE Mowers and  
Slashers acquired

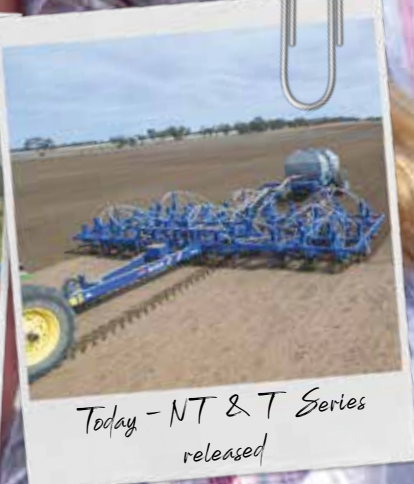

Today - NT & T Series  
released

# Contents

## PLANTERS

NT series	8
T Series	12
Planter Technologies	16

## AIR SEEDERS

Black Series (Mounted)	20
Blue Series (Medium Broadacre)	22
Platinum Series (Broadacre)	24
Options and Extras	28

## SPREADERS

Classic Series	32
Premium Series	34
Options and Extras	38

## MOWERS, SLASHERS & TOPPERS

Vineyard Mowers	42
Orchard Mowers	46
Pasture Toppers	48
Slashers	50
Broadacre Stubble Mulchers	52



**You're not in it  
just for this year's  
harvest, and  
neither are we...**



**A Gason machine  
is an investment  
in your future.**

# Planters

Gason Planter Bars stem from a rich history of strong, dependable and long-lasting machines. At Gason, we know what farmers require to maximise productivity, and have come up with a multitude of options to suit all conditions.

## **NT Series**

The smallest of the Gason Planter range. This narrow bar can be road transported without a pilot, while maintaining all of the Scaritill & Hydratill features within a working width of 8m.

## **T Series**

Developed along similar lines to the NT Series, the T Series provides a modern and reliable planter for the broadacre market. Clean and simple design, with subtle features making life easier.

- ✓ **Specific machine to meet your farming practices**
- ✓ **Multiple working width and tine spacings**
- ✓ **Floating hitch (Para-Maxx) or rigid pull (NT&T Series)**
- ✓ **Interchangeable shanks and ground tools**
- ✓ **Conventional or Minimum Till**
- ✓ **Spring or Hydraulic tine options**





**With 75 years of  
experience, Gason  
engineers understand  
Australian conditions  
and practices.**

## NT series

The NT8000 & NT6500 narrow transport planters were developed due to a growing demand for agricultural equipment to meet road transport regulations, without the need for a pilot.

Controlled traffic applications minimise crop damage and, in frame transport wheels coupled with the rigid pull provide excellent manoeuvrability. The robust frame will accept the Gason ScariTill (spring) tines and, HydraTill (hydraulic) tines.

The V folded frame with in-built flotation wheels is located on 2m centres (suited to raised beds), and press wheels provide consistent seed depth in undulating country.

**The convenience of the Hydraulic Hitch makes depth adjustment whilst maintaining a level machine simple.**

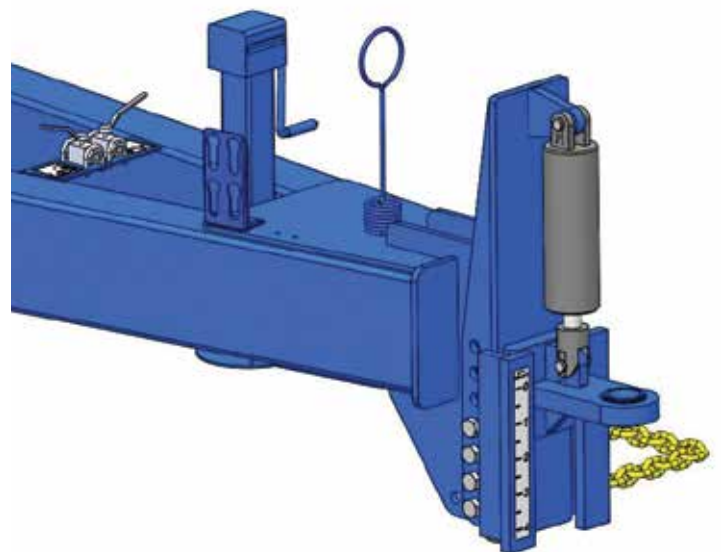





Please see your local dealer for options and extras.



**3.5m transport width**



**Pilot free transport**



**8m & 6.5m working width**



**Mounted in-frame  
flotation wheels**



**Fully compatible with Gason  
seeders and accessories**



**400lb & 540lb spring tines &  
hydraulic tines, variable up to  
680lb breakout**



**“Our property is spread over multiple locations, and the NT8000 has made it easy to get from location to location.**

**Getting around rocks and trees is a major advantage, and being able to navigate the winding roads leading to the paddocks was a huge selling point for us.”**

Mark Oxley runs a farming enterprise in Newstead Victoria, where his land is situated on hilly and undulating terrain.

## T Series

Following the success of the NT Series, the Gason T series planter arose to cater to the Australian medium broad acre market. The clean, simplistic design featuring a single row of 500/50-22.5 high flotation wheels and a rigid pull makes for a strong and manoeuvrable machine.

Frames are fitted with Gason's tried and proven ScariTILL or HydraTILL tine assemblies providing breakout from 300lb to 680lb. The T Series is compatible with 3m controlled traffic farming practices, our range of parallelogram and frame mounted press-wheels and ideally coupled with a Gason Air Seeder to provide a complete planting package.

**The Gason T series Planter was specifically engineered to give you, the farmer, a practical, functional and reliable machine.**





Please see your local dealer for options and extras.



**6.5m transport width**

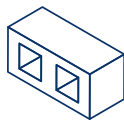

**Robust and simplistic design**



**10m & 12m working width**



**Mounted in-frame  
flotation wheels**



**Proven performance**



**Fully compatible with Gason  
seeders and accessories**

# Unlock your potential





**The Gason team listens to farmers to produce machines that meet the demands of the Australian broadacre market.**

# Planter Technologies

## Total Tine Technology

ScariTILL offers heavy duty spring release tines with cushioned recoils with two optional breakout forces, 400lbs or 540lbs.

HydraTILL's hydraulic release mechanism provides variable adjustment, up to 680lbs breakout force and a soft return mechanism. Tine assembly towers on both HydraTILL and ScariTILL models are mounted above the toolbar, for maximum trash clearance to reduce blockage through the machine.

Choose from four types of shanks, all with simple depth adjustment via holes in both the tine and holder. The individual tine adjustment allows tines to be positioned lower behind the tractor wheels to maintain a constant sowing depth, and depth can be varied across the frame to follow the contour for raised beds.

Spearpoint shanks are available with male or female adaptors. Double bolt shanks are available with either 47° or 50° forged feet.



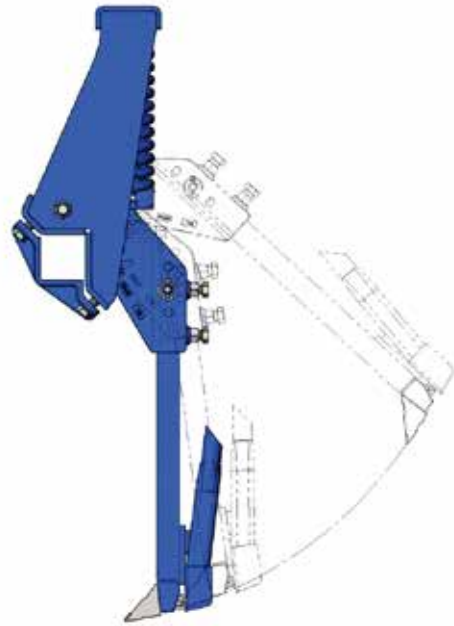

## ScariTill

- Conventional working with sweeps
- Minimum till or no till (with knife points)
- Mounted press wheels and/or coulters
- Recoil shock absorbing pads

## HydraTill

- Conventional working with sweeps
- Minimum till or no till with knife points
- Hydraulic breakout with soft recoil option
- Precision agriculture with optional parallelograms
- Mounted press wheels

# Air Seeders

Gason Air Seeders are renowned throughout Australia as a proven and reliable choice for Aussie farmers. Evolving through years of development and tireless perfectionism, you're sure to appreciate a Gason Seeder of any description.

## **Black Series (Mounted)**

For those of you who require a one machine solution, our Gason mounted bin will complete the package for your compact planter bar.

## **Blue Series (Medium Broad Acre)**

For operations which require the flexibility and features of a smaller Air Seeder, with the benefit of less fills and more seed time.

## **Platinum Series (Broad Acre)**

Our large trailed Air Seeders have been designed to keep you seeding for longer between fills, saving you precious time and resources.

**40 years in the making  
and still going strong!**





# Trust in a Gason Tillage combination to perfect your paddock



## Accurate and Reliable

Gason's proven range of air seeders are robustly engineered, highly accurate and extremely easy to use.



## Side Release Accessibility

Side Release (SR) metering system, makes cleaning and changeover an extremely fast and simple process.



## VRT

Gason air seeders are strongly built from the best materials and have a high-quality, corrosion resistant finish. They last longer, require less maintenance and retain their value.



## Many Configurations

Overall bin capacities range from 1,100 to 21,000 litres. Front tow, rear tow or implement mounted configurations are available with controlled traffic versions in 1.6m, 2m, 3m and 4m centres.

## Black Series

Make planting hassle-free with a mounted Air Seeder attached to your planter bar. Combine with a Gason NT8000 for the most compact and transportable planting setup.

Fitted with our tried and proven Series 1 Gason meter boxes as standard, with the option of Side Release (SR) meter system for unmatched functionality and user-friendliness.

Gason Black Series seeders are the perfect fit for smaller operations.



Trusted by Serafin machinery in combination with their small disc seeders, this long established relationship has blossomed due to the ease of operation, flexibility of controllers and, reliability of Gason Black Series Seeders.



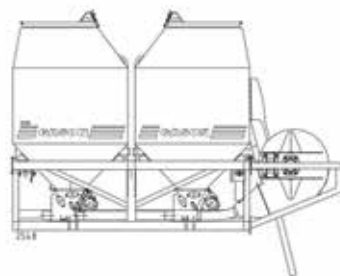

1230  
Capacity 3200 L

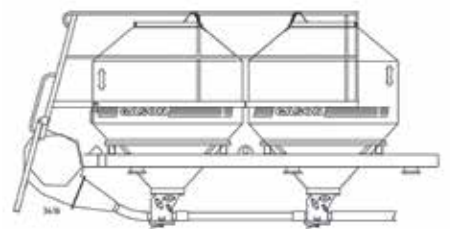

1250  
Capacity 5100 L

# Blue Series

For the controlled traffic purist, and those wanting the flexibility and functionality of small to medium sized machines. The Blue Series Air Seeders will help you to optimise planting times.

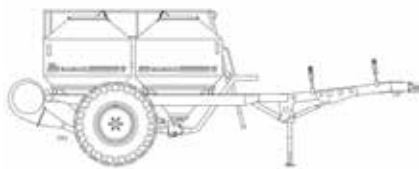

**1750/60RT**  
2 Bin Capacity 5100 L



**1860RT CTC**  
2 Bin Capacity 6200 L  
3 Bin Capacity 6490 L

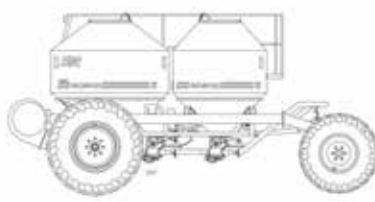

**1860RT CTS**  
2 Bin Capacity 6200 L  
3 Bin Capacity 6490 L

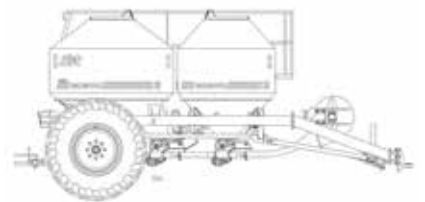

**1860FT**  
2 Bin Capacity 6200 L  
3 Bin Capacity 6490 L

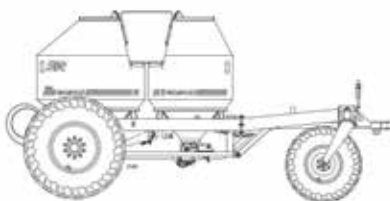

**1890RT CTC**  
2 Bin Capacity 9200 L  
3 Bin Capacity 9260 L *(non packed)*

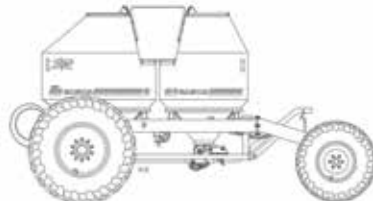

**1890RT CTS**  
2 Bin Capacity 9200 L  
3 Bin Capacity 9260 L *(non packed)*

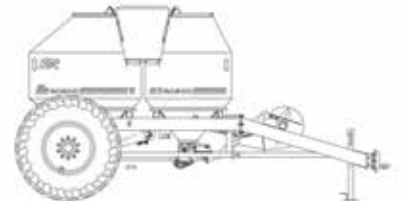

**1890FT**  
2 Bin Capacity 9200 L  
3 Bin Capacity 9260 L *(non packed)*

**From our family to yours.. Gason Air Seeder and Planters have been trusted by Australian farmers for over half a century!**



# Platinum Series

Reduce your downtime and maximise your efficiency with the Gason Platinum Series. Our 2120, 2150, 2170 & 2210 Air Seeders ensure the only time you stop operations is for lunch!

Overall capacities range from 12,400 to 21,300L in two/three bin configuration options. The unique feature of individual mounted bins gives the ability to monitor and individually calibrate each bin if fitted with load cells. Metering accuracy is assured with our easy to calibrate, Variable Rate Technology (VRT) hydraulic drive metering system.

In addition to load cells, these high capacity series models benefit from the option of fitting a pasture planter and load/unload auger. A range of monitoring options can be accommodated (contact your dealer for further details).





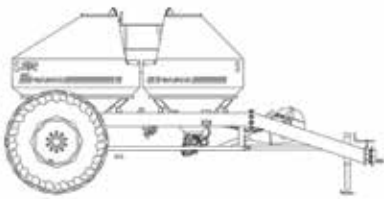

**2120FT**

2 Bin Capacity 12,400 L  
3 Bin Capacity 12,600 L

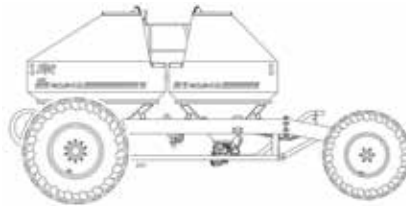

**2120RT CTS**

2 Bin Capacity 12,400 L  
3 Bin Capacity 12,600 L

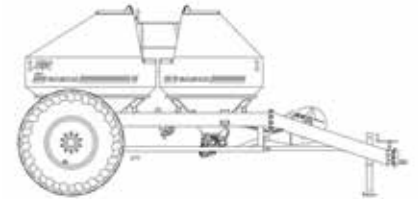

**2150FT**

2 Bin Capacity 15,150 L  
3 Bin Capacity 15,300 L

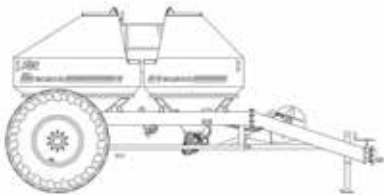

**2150RT**

2 Bin Capacity 15,150 L  
3 Bin Capacity 15,300 L

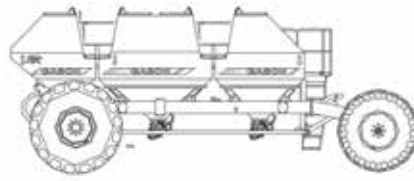

**2170RT CTS**

3 Bin Capacity 17,250 L

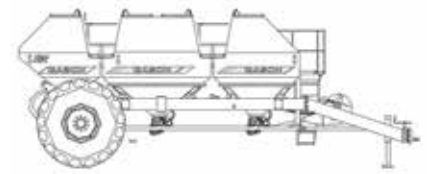

**2170FT**

3 Bin Capacity 17,250 L

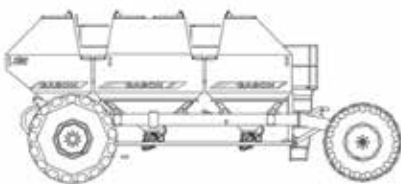

**2210RT CTS**

3 Bin Capacity 21,370 L

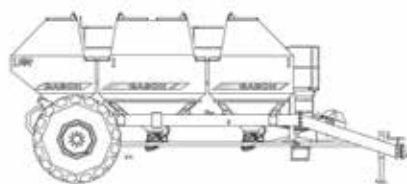

**2210FT**

3 Bin Capacity 21,370 L

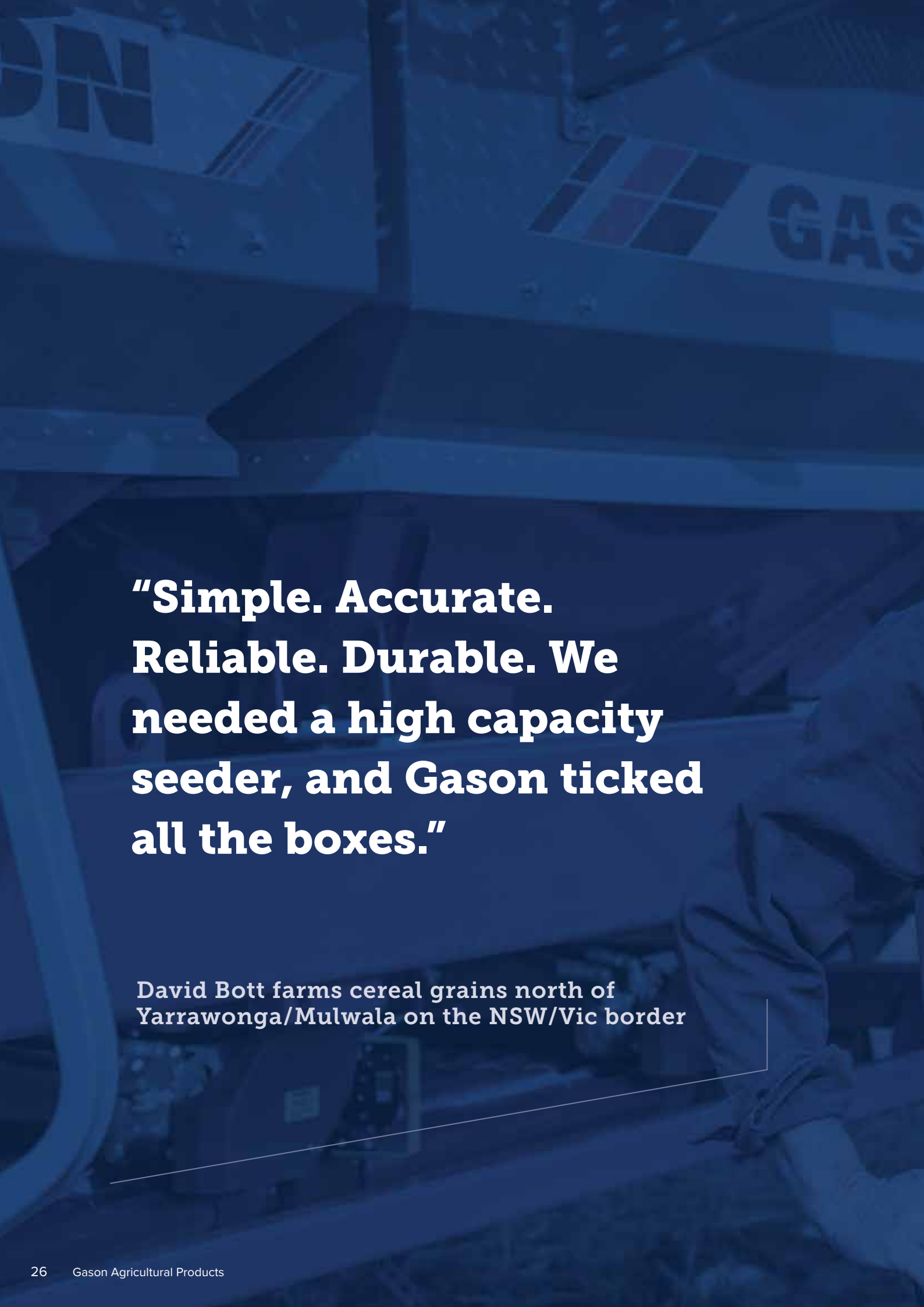

**“Simple. Accurate.  
Reliable. Durable. We  
needed a high capacity  
seeder, and Gason ticked  
all the boxes.”**

David Bott farms cereal grains north of  
Yarrawonga/Mulwala on the NSW/Vic border



# Options and Extras

## Black, Blue & Platinum Series Air Seeders

### Loading/Unloading Auger & Diverter Systems *(Blue & Platinum Series only)*

Large capacity and efficient auger mounted on pivoting arms for manoeuvrability. Supplied standard with work light.

### Air Warmer Kit

An air intake warmer kit can be fitted to overcome problems associated with early morning dampness and high moisture content fertiliser. Intake air to the fan is preheated using hydraulic oil returning from the motor and passing through the heat exchanger. A bypass valve protects the heat exchanger from excessive return line pressure while ensuring oil is not dumped on the ground.



## **Rear Hitch Kit** *(Blue & Platinum Series only)*

A rear hitch kit for towing harrows or the like can be fitted to most rear tow seeders.

## **Small Seeds Box**

A 380L litre small seed box can be fitted to seeders of capacity less than 6,000L. A 600L small seed box can be fitted to seeders of capacity greater than 6,000L. Gason small seed Boxes are capable of metering low rates of pasture seed to high rates of rye grass. Extremely user friendly and easy to calibrate.

There are three distribution options:

- Broadcasting behind the tillage planter using spreader plates
- Individual placement behind every tine
- Through the main distribution system using a combiner “Y” kit

## **Additional options include:**

- Internal Bin Light
- Load Cells
- Rear Walking Kit

For availability, contact your local dealer



# Spreaders

Gason Spreaders have been used for more than 20 years in all regions of the country - from far north Queensland to Kangaroo Island. Every model is designed to cater for Australian conditions, and capable of handling almost any product - from chicken litter and compost to urea, pelletised phosphates and lime.

Gason Spreaders feature world class design, made from quality materials that will endure.



## **Classic Series – Standard Spread**

Simple and effective solutions for the Aussie farmer.

## **Premium Series - Wide Spread**

Highest capacity and performance Spreaders, for unbeatable performance.





### Slat styled feed chain

Ensures even flow of product through to the discharge area without slipping or creating blockages.



### Twin spinners

Hydraulically operated and engaged from the tractor cabin



### Widespread spinners

Can spread pelletised fertiliser to 36m (Kondinin certified)



### Centre vee

Provides increased flexibility when changing from different products such as lime, gypsum and urea.



### Ground drive mechanism

Automatically adjust application rates as ground speed is increased or decreased



### Load Cells

Effectively monitor how much product remains in the bin from the tractor cabin in real time

# Classic Series

Gason Spreaders are simple to operate and are highly efficient. Manufactured from heavy gauge steel and coated with two pack paint for superior corrosion protection, they will give you years of reliable service.

If you're looking for a tough and dependable spreader for fertiliser or manure, a Gason Classic is the ideal machine.



## 3 tonne

The classic Gason 5030 spreaders are ideal for small plots and operations which reside on undulating countryside. This low profile spreader can manoeuvre easily through tight areas such as orchards.

## 7 tonne

A farmer's bread and butter. The 7 tonne spreader is a versatile general purpose machine, ideal for spreading a variety of products from gypsum, lime, chicken manure and granular product.







# Premium Series

## Spread with accuracy

The broadacre range of VRT Spreaders come in the largest size for maximum spread-ability. Combining the versatility of a Gason spreader with the latest innovations in technology, the VRT range will cover any of your spreading requirements.

You'll be spreading with ease with an abundance of optional extras such as load cell, hungry board and tarp kit.

2 supplied sets of Spinners make these premium spreaders easily interchangeable from general purpose to granular fertiliser.

A range of monitoring options can be accommodated for the Premium Series spreader range. Contact your dealer for further information.

### 9 tonne

A popular size variant for good reason! The 9 tonne VRT spreader is the perfect all-rounder, with many of the benefits of it's larger sibling within a smaller machine.

### 12 tonne

Maximise your capabilities with the largest of the Gason spreader range. Contractors and broad acre farmers will love the sheer capacity of these solid machines!



**KONDININ**  
**G R O U P**®

Gason Premium Series Spreaders have been field tested by Kondinin Group, and accredited to spread granular products accurately to 36m.



**With VRT hydraulic metering, widespread spinner discs and centre vee as standard - you'll enjoy the full capabilities a Gason Spreader can provide.**



**“We’ve been running the Gason gear for the last 12 years, and needed big capacity spreader.**

**Changing product is as simple as changing the discs, and we can cover around 70 hectares per hour on average.”**

Dale and Chris Bartlett are 5th generation farmers situated in Pimpinio, Western Victoria. Their family grew their first crop here in 1870’s, and have been cultivating ever since.



# Options and Extras

## Hungry Boards

Can be fitted to increase capacity for lighter materials - available as standard or an option on most models.

## Tarp Kit

Fitted with long handle for ground operation.

## Heavy Duty Spinners

Sold in pairs and are suited to spread chicken manures, where material may be contaminated or extremely heavy. Heavy duty spinners are supplied with low profile fins and thicker base material. They are NOT designed to spread pelletised material.



### **Calibration Kit**

Consists of 2 collection trays, sample bag, digital scales and carry frame. Useful for determining the accuracy of the door height for light rates of pelletised product. Only available for 7 tonne models.



### **Load Cells**

Effectively monitor how much product remains in the bin from the tractor cabin in real time.

### **Tail Light Kit**

LED indicator and brake lights for safer on-road transportation.

### **Independent Feed Chain & Spinner Hydraulic Kit**

Available on Ground Drive models to separate the gearbox control from the spinner.

- Hydraulic drive feed chain for full VRT use.
- Dynamic calibration option available on ISOBUS controller options.

### **Beacon Light Kit**

Rotating LED amber beacon light mounted at the back of the spreader, compliments the tail light kit.



# Mowers, Slashers & Toppers

The Gason range of mowers and slashers are a prime example of Australian ingenuity. Years of innovation from Chris Grow Engineering, combined with continuous improvement from the team at Gason have resulted in a fine range of mowing solutions, delivering great results to contractors and agriculturalists alike.



From 5ft Vineyard Mowers to 41ft Cropper Toppers, there is sure to be a Gason mower to suit your needs.

## **Vineyard Mowers**

Viticulturists will appreciate the perfect width, manoeuvrability and side throw convenience of our range of Rapier Mowers.

## **Orchard Mowers**

The compact depth and generous cutting widths of a Gason orchard mower will make life easy when tending to your orchards.

## **Slashers**

Contractors will love a Gason VHD Slasher - built tough, it will make light work of overgrown areas in rough terrain.

## **Pasture Toppers**

Designed for high speed clean cutting of pasture. Cattle, sheep and horse properties all benefit from regular pasture topping.

## **Broadacre Stubble Mulchers**

Our range of Cropper Toppers come with the same strength and reliability you've come to expect from Gason agricultural products – mulching high bulk with even spread for non-clog direct planting.





**Field tested and  
developed specifically  
for your requirements**

# Vineyard

The Gason range of Vineyard Mowers have been a long-time favourite of Australian and New Zealand for over 35 years.

Our inter-row Vineyard Mowers manage the sod culture between vine rows at a consistent height.

Side throw features roll out beneficial mulch under vine, with anvils to mulch prunings when discharged at the rear.

Gason Vineyard mowers have built an enviable reputation for long and dependable service life amongst Australian and New Zealand viticulturists, and continue to provide impeccable results.

Gason Vineyard mowers come in a range of sizes (1.6-2.4m) and models (Front Mounted, Rear Mounted and, Drop Centre).





## Trusted by vignerons for more than 30 years!



### Single Rotor

The single rotor model has tapered rear corners which assist with entering and exiting vineyard rows, particularly those with narrow headlands or large strainer posts.



### Twin Rotor

This machine has been used extensively in many of the leading vineyards in Australia and New Zealand. They are built tough and provide maximum performance!





**“Our vineyard mower  
has outlasted 3 tractors  
totalling approximately  
20,000 hours of operation.**

**If only everything was  
built as strong.”**

Andy Luffman, National Plant & Equipment  
Manager of Delegat Wines, South Island New  
Zealand. Their fleet of approximately 40 Gason/  
CGE vineyard mowers are still going strong.

# Orchard

The Gason Twin & Triple Rotor Orchard Mowers have remained the long-time favourite of Australian and New Zealand orchardists since their inception. Their compact depth and generous cutting width give you the luxury of a 'one pass cut' down the row.

- ✓ **Comes in VHD variety for heavy duty applications**
- ✓ **Flat deck, Drop Centre and Winged models available**
- ✓ **Operated with tractors ranging from 70-200hp**

Gason Orchard mowers come in a range of sizes, from 2.5-4.1m.

Some Slashers such as the Delta Wing can be used comfortably for orchard mowing.



\*Discontinued model pictured



## The orchard industry's favourite mower

Standard features include - front and rear height adjustable 200mm (8") diameter 'domed end' rollers and the ability for side discharge of cuttings under tree, or fit full side cover plates for rear discharge and mulching of prunings up to 50mm in diameter.

For contoured rows, the winged model is available. This machine floats freely from basin ground form to flat ground profile.

# Pasture Topper

Growing sound pastures is an important requirement for professional farm and stud managers across the nation. Dairy farmers are aware that increased milk production is achieved by a regular pattern of grazing, topping and irrigation. Horse studs, sheep and beef cattle operations can all benefit from pasture topping.

Both the Gason 3PL and Trailed Pasture Toppers are designed to help you achieve a better outcome on your farm.

## Gason Pasture Toppers

Grazing farmers love Gason Pasture Toppers, with their 6mm steel deck, 8mm side plates, heavy duty skid plates, and a fully welded head stock.







## Watch your productivity grow

The following features of our Pasture Toppers mean they are suitable for all conditions;

- ✓ **Range of sizes: 2.4m, 3m, 3.6m**
- ✓ **Spread evenly without windrowing**
- ✓ **Cutting design eliminates wheel marks**
- ✓ **Hydraulic adjustable rear guard**
- ✓ **High speed, sharp clean cutting, enabling more efficient ground coverage**
- ✓ **Quality heavy duty spring steel skids**
- ✓ **Height adjustable side plates with secure lock & dog**

# Slasher

Invest in the perfect slasher for your situation - whether you need manoeuvrability, durability or consistent cutting height, there is a slasher solution to suit your requirements.

A go to when tackling fire breaks, slashing under powerlines, roadside maintenance or rail verges. As the Gason tagline suggests, our Slashers are built to last!

## A tough and dependable Aussie built slasher – engineered for the big country!

### Delta Wing

Our Delta slashers are a real crowd pleaser, designed for contractors, orchardists and government users requiring an easily manoeuvrable, dependable and reliable machine

### VHD Slasher

Gason VHD slashers are highly customisable and come in a variety of models: with 3 point linkage or trailing, taper back, single rotor or multi-rotor models available.

Gason Slashers come in a range of sizes, from 1.8-6.1m





**Designed and  
constructed for the  
most demanding public  
works and broadacre  
slashing conditions.**

# Broadacre Stubble Mulcher

The range of Gason Cropper Toppers have a pedigree of reliable and dependable service that comes from more than 75 years of manufacturing products for Australian conditions.

Cereal and cotton growers will love this field proven mulcher for its all gear drive system and high trashing efficiency.

## Broadacre Cropper Topper

24ft, 31ft, 35ft and 41ft (7.3m - 12m) models come equipped with a range of benefits

- ✓ **Power matched PTO shafts/ torque cushion couplings between gearboxes**
- ✓ **Level lift phased hydraulic cylinders to adjust deck height**
- ✓ **Height adjustable draw bar**
- ✓ **Dual mulching blade assemblies**
- ✓ **20 ply stubble tyres**
- ✓ **Hinged rear safety guards**

## Trailed Cropper Topper

- ✓ **350hp driveline**
- ✓ **Suitable for 150-600HP tractors**





**Innovatively designed and expertly manufactured, Gason's range of Cropper Toppers provide industry leading performance in the paddock!**



**“The Cropper Topper does a really great job of mulching the paddocks, with nice fine cuts and low maintenance.**

**Gason build a tough reliable machine, and service our needs really well”**

Dean Heard has owned 11 Gason Cropper Toppers, used for his agricultural contracting business in Lower Norton, Western Victoria.



# From our family to yours...

After WWII and seeking new opportunities, Frank Gason, his wife Jean and their young family moved from Geelong to Ararat, Victoria and started AF Gason Pty Ltd. For over three quarters of a century since, continuous generations of the Gason family have been living and working in this Rural City, with their presence remaining strongly felt in the community to this day. Of course, as the Company grew and became one of the largest regional employers in the area, the Gason name has become recognised not only locally but also nationally and internationally.

With core values of honesty, respect and openness, the family have endeavoured to ensure that the wellbeing of their staff, their families and the community in which they live and work is paramount. Whenever practically possible, the importance of achieving a positive work/life balance is considered in the daily operations of the Company – in fact one of the business's operational rules is to value family life within the community! From supporting local churches, schools, sport clubs and community groups through finance, advice, leadership, and participation, the Gason family have certainly settled and, are committed to this great part of country Victoria.

A family and business that have always strived to ensure the sustainability of employment through good times and bad whilst demonstrating integrity, ethical conduct, honesty and fairness in all their business dealings, the Gason family desire to provide employees with challenges,

opportunities, and personal satisfaction whilst recognising their value and contribution.

From the humble beginnings of the motor trimming business in January 1946, many members of the Gason clan have worked permanently or on a part-time basis in the business. At the time of publication, 6 members of the family, spanning 3 generations, fulfil prominent roles with the manufacturer:

Les Gason | Chairman of the Board of Directors

Greg Gason | Agricultural Division Manager and Director

Wayne Gason | Managing Director

Oakley Gason | Marketing Coordinator

Morgan Gason | Heater Division Manager

Riley Gason | Industrial Services Engineer

Highly capable in their own specific fields, with over 150 years of experience shared between them, the Gason family members are proud of the business's heritage and are committed to continue conceptualising, designing, manufacturing and assembling high quality agricultural machinery tailored for the Australasian market - machinery that is producer proven and as their Father, Grandfather, and Great Grandfather Frank would say, *"Built to Last...because it's Gason."*





*Pictured L-R: Riley, Oakley, Wayne, Les, Morgan and Greg Gason.*

75 years



**GASON**

*years*



*Built to Last.  
1946 - 2021*



**Your local Gason dealer**

Note: All information in this brochure was correct at the time of printing, June 2020, however Gason Pty Ltd reserve the right to change specifications without notice. Colours shown are as close as printing method allow. For further information on the model range please contact your local Gason dealer.



**AF Gason Pty Ltd**  
Phone: 03 5352 2151  
Blake Street Ararat, Victoria 3377 Australia  
sales@gason.com.au

**[www.gason.com.au](http://www.gason.com.au)**